



DT43/D4 USER MANUAL(EN)

## 2-Wire Video Intercom System



① Read this manual carefully before using the product, and keep it well for future use.

## 1.Parts and Functions

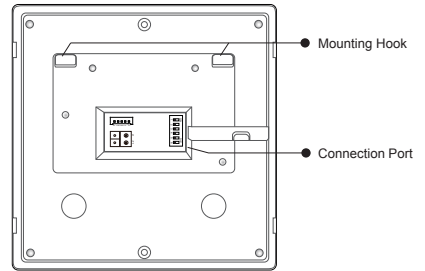
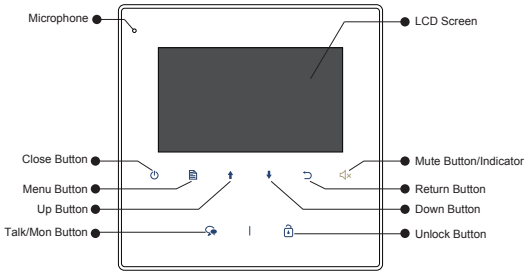

### Terminal Description

**SW+,SW-:** Door bell call button connection port.

**Ring,GND:** Extra buzzer connection port.

**NC:** Reserved.

**L1,L2:** Bus terminal.

**DIP switches:** Total 6 bits can be configured.

**Bit1~Bit5:** Used to User Code setting.

**Bit6:** Set to ON if the monitor is at the end of the line or works with DBC4A. Otherwise, set to OFF.

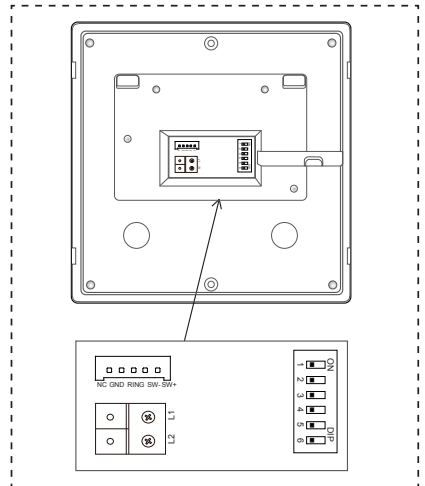

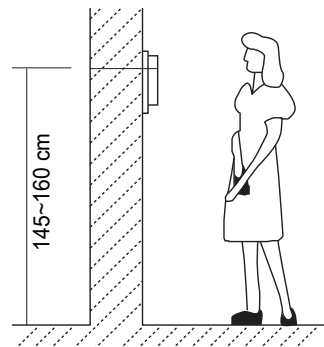
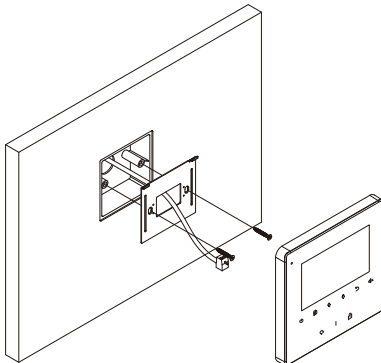

## 2.Monitor Mounting









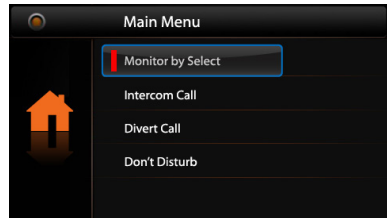

1. Use the screws to fix the Mounting Bracket on the mounting box.(fitting accesories includes a Bracket (Two pieces of 4X25 screws are needed for fastening the Mounting Bracket), Special 2 wire connectors to connect with Monitor)
2. Wire the system correctly(see the later connection chapter) then hang the Monitor on the Mounting Bracket firmly.

### 3. Main Menu

Press  **Menu** /  **Close** button, in standby mode, the main menu page will be shown as follows:









### 4. Basic Door Release Operation

1. Press **CALL** button on outdoor station, the Monitor rings, meanwhile, the screen displays the visitors' image.
2. Press  **Talk/Mon** Button on monitor, you can communicate hands free with the visitor for 90 seconds. After finishing communication, press  **Talk/Mon** button again(or press  **Close** Button) to end the communication. If nobody answers the phone, the screen will be turned off automatically after 40 seconds.
3. During talking state, Press  **Unlock** Button to release the first door.
4. When the monitor is in standby mode, press  **Talk/Mon** Button (or select **Monitor By Select** button on main menu, press  **Menu** Button to confirm, and then it will enter the select a camera page, then you can use  /  Button to select the camera you want), the screen can display the view of outside.



## 5. Intercom Function

When the monitor is in standby mode, press  **Menu** Button to enter main menu page. Use  /  Button to move upward / downward to select **Intercom Call** item, press  **Menu** Button to enter the select intercom page, you have 3 items to select.

1. **Namelist Call:** User in one apartment can call other apartments in the system. the namelist will be created automatically by the system. Use  /  Button to selete a name on the screen then press  **Menu** Button to call. (Note: 1. Press "MENU" button again to redial. 2. The DIP switches code of the monitors are not the same.)

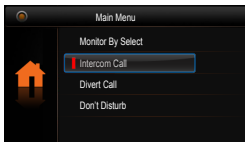

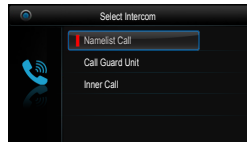

Use  /  button to selete **Intercom Call** item, then press  **Menu** button to confirm.

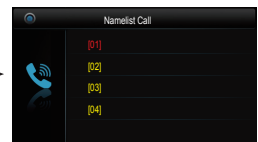

Use  /  Button to selete **Namelist Call** item, then press  **Menu** button to confirm.





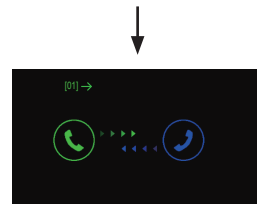

Use  /  Button to selete the item you want, then press  **Menu** button to call.





Calling.

2. **Inner Call:** If multi Monitors are installed in the same apartment, select Inner Call, all the other Monitors will ring at the same time, whichever Monitor answers the call, conversation is started, and the other monitors will stop ringing at the same time. (note: the DIP switches setting of all monitors must be same. )
3. **Call Guard unit:** A Monitor can be assigned as Guard Unit Monitor; when the Guard Unit Monitor answers the call, conversation with the guard person is started.



## 6. Divert Call Function

When the monitor is in standby mode, press  **Menu** Button to enter main menu page. Use  /  Button to move upward / downward to select **Divert Call** item, press  **Menu** Button to enter the call divert options page, you have 4 items to select.



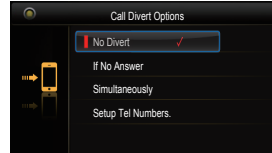



Use  /  button to select **Divert Call** item, then press  **Menu** button to confirm.







Use  /  Button to select the item you want, then press  **Menu** button to confirm.

1. **No Divert**----calls from outdoor station will not be diverted.
2. **If No Answer**----Calls form outdoor station without respond in 30 seconds will be transfer to the number you set.  
Even though the monitor will shut off when transfer via TPC/GSM/TPS, you still available to operate it (such as monitor, talk, and unlock).
3. **Simutaneously**----Calls from outdoor station will be diverted to your telephone immediately. At this mode, the monitor won't shut off when TPC/GSM/TPS divert sucessfully, but if the monitor answers the call at this time, TPC/GSM/TPS will quit absolutely.
4. **Setup Tel Numbers**.----Select this item to edit the divert numbers you want.

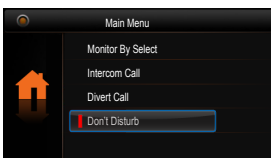
## 7. Don't Disturb Function

When the monitor is in standby mode, press  **Menu** Button to enter main menu page. Use  /  Button to move upward / downward to select **Don't Disturb** item, press  **Menu** Button (or press  **Mute** Button/Indicator directly) to enter the no disturb page, you have 4 items to select.





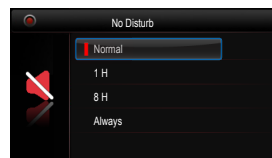

Use  /  button to select **Don't Disturb** item, then press  **Menu** button to confirm.



Use  /  Button to select the item you want, then press  **Menu** button to confirm.

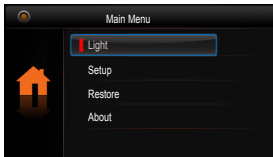

## 8.Light Function

When the monitor is in standby mode, press  **Menu** Button to enter main menu page. Use  /  Button to move upward / downward to select **Light** item, press  **Menu** Button to enter the light Option page, you have 3 items to select.

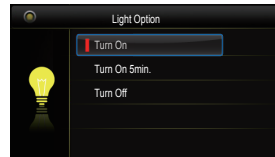

Use  /  button to select **Light** item, then press  **Menu** button to confirm.







Use  /  Button to select the item you want, then press  **Menu** button to confirm.

1. **Turn On**: Select it to open the staircase light, the staircase light will be turned off automatically after 60 seconds.
2. **Turn On 5min**: Select it to open the staircase light, the staircase light will be turned off automatically after 5min.
3. **Turn Off**: Select it to close the staircase light.

Note: the staircase light function will be activated only when the system connect light via DT-RLC module, otherwise, this function is invalid in normal. For more information, please refer to DT-RLC user instruction in detail.

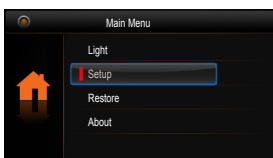

## 9.Setup Function

When the monitor is in standby mode, press  **Menu** Button to enter main menu page. Use  /  Button to move upward / downward to select **Setup** item, press  **Menu** Button to enter the user setup page, you have 4 items to select.



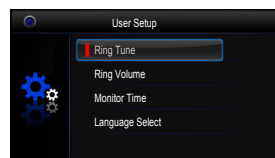



Use  /  button to select **Setup** item, then press  **Menu** button to confirm.







Use  /  Button to select the item you want, then press  **Menu** button to confirm.

1. **Ring Tune**: Select it to set the tune of Door Station, Intercom and Door Bell.
2. **Ring Volume**: Select it to set the volume of monitor.
3. **Monitor Time**: Select it to set monitor time.
4. **Language Select**: Select it to set the language.

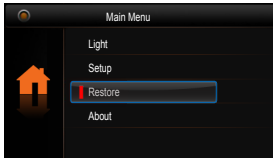
## 10. Restore to Default

When the monitor is in standby mode, press  **Menu** Button to enter main menu page. Use  /  Button to move upward / downward to select **Restore** item, press  **Menu** Button to enter the restore page, and then press  **Menu** Button to confirm.



Use  /  button to select **Restore** item, then press  **Menu** button to confirm.

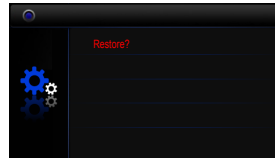



Press  **Menu** button to confirm.

## 11. Monitor Parameter Setting

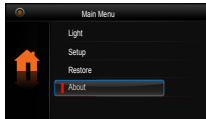
### 11.1 How to enter the installation setting page



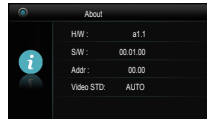

Use  /  button to select **About** item, then press  **Menu** button to confirm.

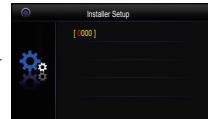

Press  **Unlock** button and hold for 3s.



Use  /  button to increase/decrease the value you want, and press  **Menu** button to confirm.

### 11.2 The setting items are as followings

[8000]:Master 0

[8001]~[8003]:Slaver 1~3

[8004]:Guard unit

[8005]:Not guard unit

[8006]:Panel on as slaver called

[8007]:Panel off as slaver called

[8014]:Unlock menu on

[8015]:Unlock menu off

### 11.3 How to set the monitor as a Guard Monitor

A Monitor can be assigned as Guard Unit Monitor; when the Guard Unit Monitor answers the call, conversation with the guard person is started..

The code number of 8004 is used to set the monitor as a guard unit monitor and 8005 is used to cancel this function.

## 11.4 How to set the slave monitor address

Maximum 4 monitors can be connected in one apartment, one master monitor together with 3 slave monitors, so you should set the address correctly. (note: must have one monitor to be set as master monitor)

The code of 8000 is used to set the master monitor.

The code of 8001 is used to set the first slave monitor.

The code of 8002 is used to set the second slave monitor.

The code of 8003 is used to set the third slave monitor.

## 11.5 How to set the monitor panel on

In default mode, when receive a calling, the master and slave monitors will ring at the same time, and just the master monitor can display the image while the slave monitors can not. But the settings can be changed, you can set the master monitor and all the slave monitors to panel on at the same time when receiving a call, just input the code number of 8006 on each slave monitor.

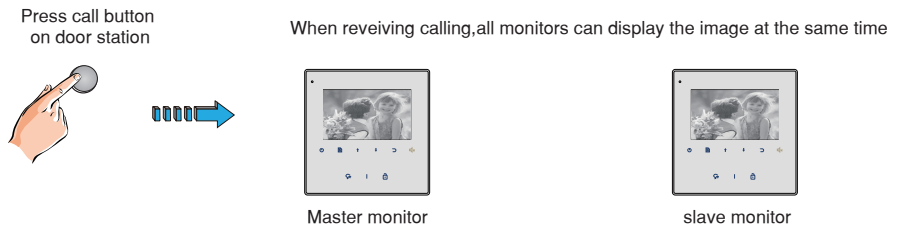

## 11.6 How to set the unlock parameter

### Unlock mode:

There are two unlock modes: 1. power-on-to-unlock type: unlock mode=0 (by default)

2. power-off-to-unlock type: unlock mode=1.

The code number of 8010 is used to set the unlock mode to 0

The code number of 8011 is used to set the unlock mode to 1

### Unlock time:

The unlock time can be changed by yourself at any time. It can be set from 1 to 9 seconds.

The code number from 8021 to 8029 are used to set the unlock time to 1~9 seconds.



### 11.7 User Code Setup

In the DT system, every apartment must have a unique identification called User Code. The DIP switches are used to configure the User Code for each Monitor.

- Bit-1 to Bit-5 are used to User Code setting. The value is from 1 to 32, which have 32 different codes for 32 apartments.
- When multi Monitors are installed in one apartment, these Monitors have to use the same User Code setting, and the Master/Slave mode should be set on the Monitor.
- Bit-6 is line terminal switch, which have to be set to ON if the Monitor is in the end of the line (bus), otherwise set to OFF. The end of the line is terminal that no other section will start from it.

Bit-6 line terminal setting:

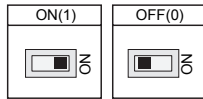



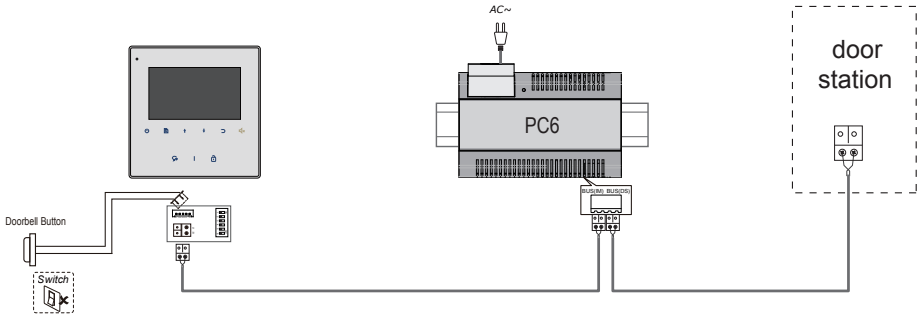

Bit state	Setting	Bit state	Setting
	Monitor not at the end of the line.		Monitor at the end of the line.

Bit state	User Code	Bit state	User Code	Bit state	User Code
	Code=1		Code=12		Code=23
	Code=2		Code=13		Code=24
	Code=3		Code=14		Code=25
	Code=4		Code=15		Code=26
	Code=5		Code=16		Code=27
	Code=6		Code=17		Code=28
	Code=7		Code=18		Code=29
	Code=8		Code=19		Code=30
	Code=9		Code=20		Code=31
	Code=10		Code=21		Code=32
	Code=11		Code=22		

## 12. Basic Connection



## 13. Screen and Volume Adjustment

During monitoring or talking, press  **Menu** Button, the *ADJUST MENU* will be displayed. Use  **Menu** Button to select the adjustment item; use  /  Button to decrease / increase the value, press  **Return** Button to quit the adjust page.

1. Total 4 screen modes can be selected in sequence: *Contrast, Bright, Color* and *Volume*.
2. The *Bright* and *Color* item is for the image quality setting, adjust the value to get the best image you like.
3. The *Volume* items are ring tone and talking volume adjustment.



## 14. Specifications

- Power supply for indoor monitor: DC 20~28V
- Power consumption: Standby 0.17W; Working status 4.7W
- Monitor screen: 4.3 inch digital color TFT
- Display Resolutions: 380(R, G, B) x 272 pixels
- Video signal: 1Vp-p, 75Ω, CCIR standard
- Wiring: 2 wires, non-polarity
- Monitor time: 40 seconds
- Talking time: 90 seconds
- Dimensions: 137(H) × 137(W) × 17(D)mm

The design and specifications can be changed without notice to the user. Right to interpret and copyright of this manual are preserved.